

kielle

30102003

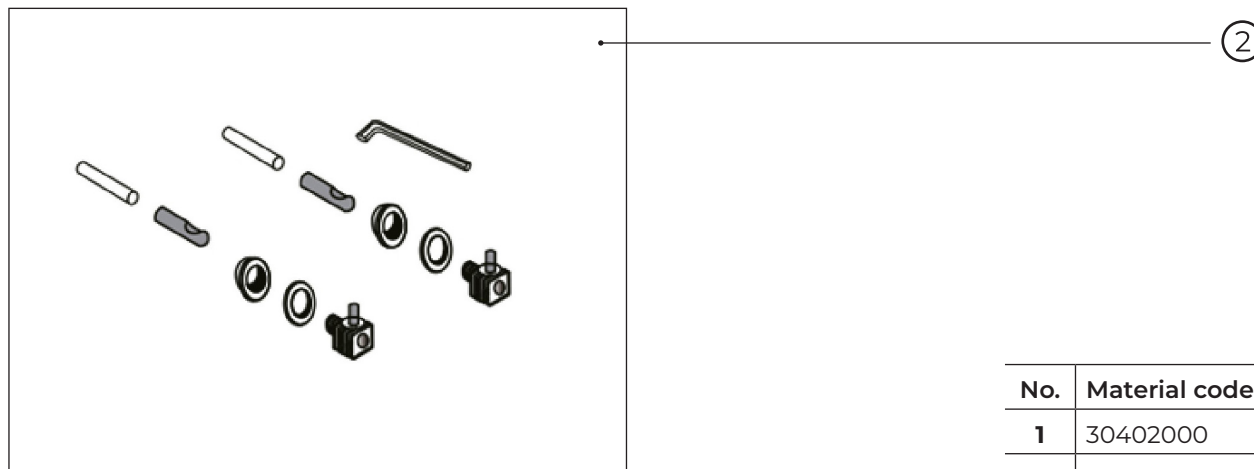
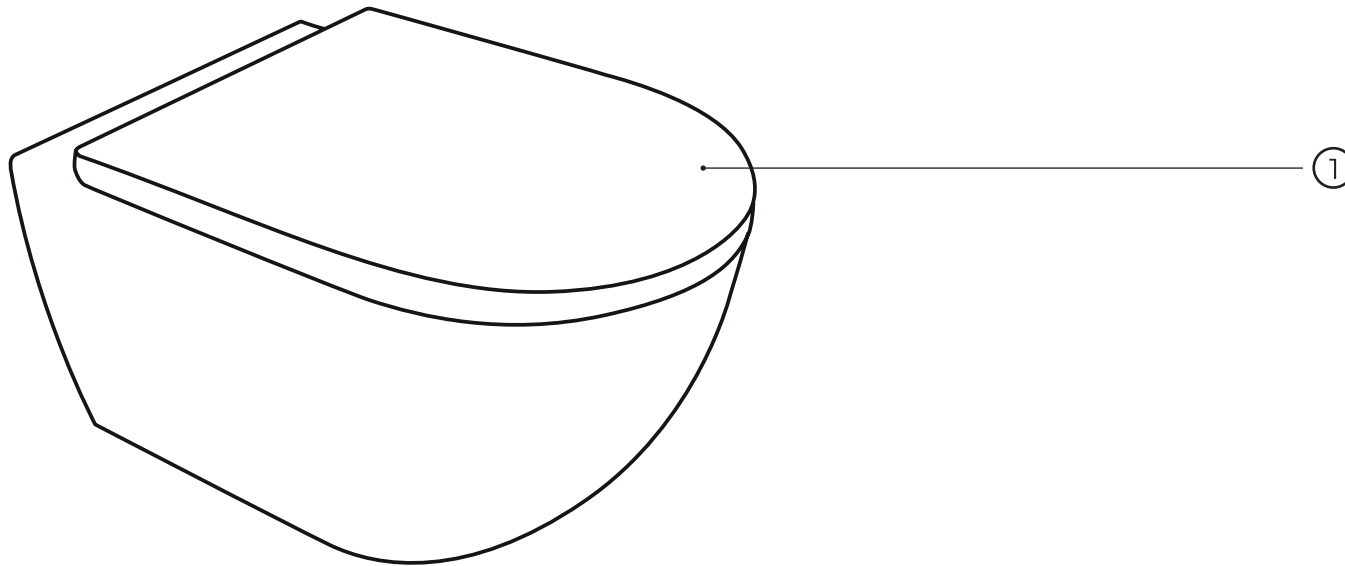

No.	Material code	Name	QTY
1	30402000	Seat	1
2	30903001	Fixation set	1